



ECOSCAPE[®] UK

COMPOSITE DECKING, FENCING & CLADDING

ecoscape.co.uk

01706 364637 | sales@ecoscapeuk.co.uk

RESPONSIBLE DESIGN
OUTSTANDING QUALITY
EXCEPTIONAL EXECUTION

Make No Compromise



The mark of
responsible forestry
FSC® C108654



CONTENTS



4 CLARITY COMPOSITE DECKING

12 FORMA COMPOSITE DECKING

22 BALUSTRADE SYSTEMS

26 FORMA PANEL CLADDING

36 FORMA SLATTED CLADDING

44 COMPOSITE FENCING & GATES

52 PEDESTAL SYSTEMS

60 FORTE TIMBER FREE SUBSTRUCTURES



INNOVATIVE & SUSTAINABLE DESIGN

As manufacturers of wood plastic composite products, our collection includes attractive low maintenance decking, cladding, fencing and balustrade systems.

We aim to be at the forefront of the garden design industry with excellent quality, stylish and efficient systems that not only look beautiful but perform to the highest standard.

We use recycled plastic in all of our composite products. In 2021 alone we recycled **4,495** tons of waste plastic in our materials.



MIDNIGHT
Forma Composite
Slatted Cladding

CLARITY® COMPOSITE DECKING

Ecoscape Clarity® composite decking is a long lasting, low maintenance alternative to timber decking. Made up of recycled high density polyethylene plastic and reclaimed wood fibres. This unique makeup draws on the durability of synthetic products whilst maintaining the natural look and malleability of timber without any of its notable drawbacks.

This attractive and sustainable composite decking board is available in 5 beautiful colours and has a dual surface finish meaning the board can be laid either side up or side down to achieve a different aesthetic.

Our Clarity boards have also been independently tested to BS 7976-2:2002 and are proven to be non-slip in both wet and dry conditions making family safety one of its most attractive selling points.



Our T-clip fixing system is purposefully engineered for both quick and easy installation whilst maintaining a high quality finish.

The T shaped clips space decking boards evenly allowing for expansion and contraction with temperature fluctuation.



CHARCOAL
Clarity Composite Decking

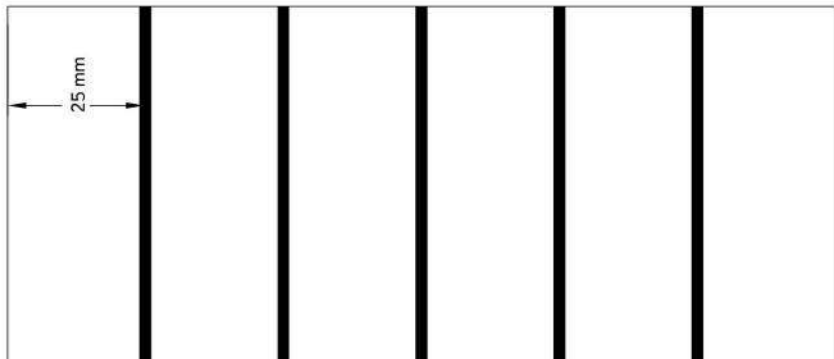
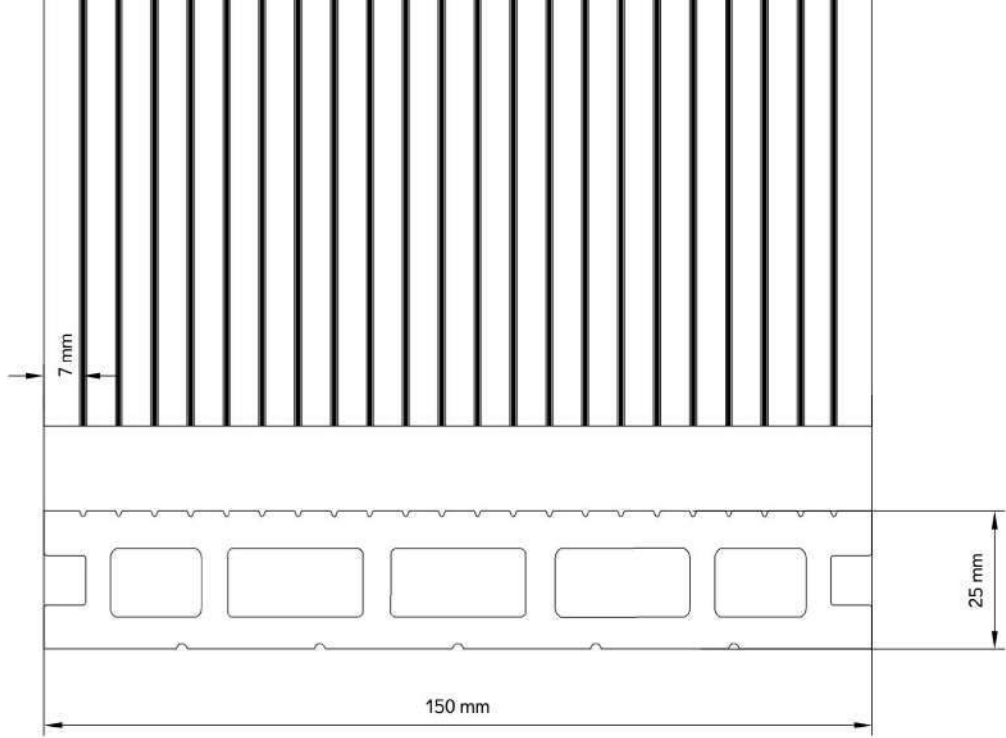

CLARITY® COMPOSITE DECKING

Walnut

25mm x 150mm x 3000mm
25mm x 150mm x 4800mm



Ash

25mm x 150mm x 3000mm
25mm x 150mm x 4800mm



Autumn

25mm x 150mm x 3000mm
25mm x 150mm x 4800mm



Dual surface board; Side 1 wide groove, Side 2 narrow groove



NOTE: Lighter Clarity Boards will show greater colour settling due to smaller quantities of dye and greater UV exposure to the natural wood fibres. After 3 months of UV exposure product colour remains consistent.

Charcoal

25mm x 150mm x 3000mm

25mm x 150mm x 4800mm



Graphite

25mm x 150mm x 3000mm

25mm x 150mm x 4800mm



CLARITY® COMPOSITE DECKING ACCESSORIES

Angle Fascia Trim
42mmx6mmx3000mm



Flat Trim
150mmx15mmx3000mm



Solid Edge Board
25mmx150mmx3000mm



Hidden T-Clip Fixings
250 pcs
incl. screws and 1 drill bit



Locking Clip Fixings
50 pcs



Start/Finish Clips
50 pcs



Colour Coded Screws
50 pcs





BENEFITS OF CLARITY[®] DECKING

Environmentally conscious design using 95% ethically sourced materials

Anti-slip Surface

Low maintenance – no need to paint, stain or seal

Does not rot, warp or splinter

Natural looking without many of the drawbacks of timber

Quick and easy Installation system with invisible fixings

Extensive 20 year warranty



FLINT
Forma
Composite Decking



FORMA® COMPOSITE DECKING



Forma Composite decking is our premium composite with a durable polymer outer shell encapsulating the board. This capping forms an impermeable layer that protects from scratching, staining and fading making it the ultimate carefree, low maintenance flooring.

Available in six beautiful colours this stylish and sustainable decking board can instantly elevate any project into a luxury space.

Our T-clip fixing system is purposefully engineered for both quick and easy installation whilst maintaining a high quality finish.

The T shaped clips space decking boards evenly allowing for expansion and contraction with temperature fluctuation.

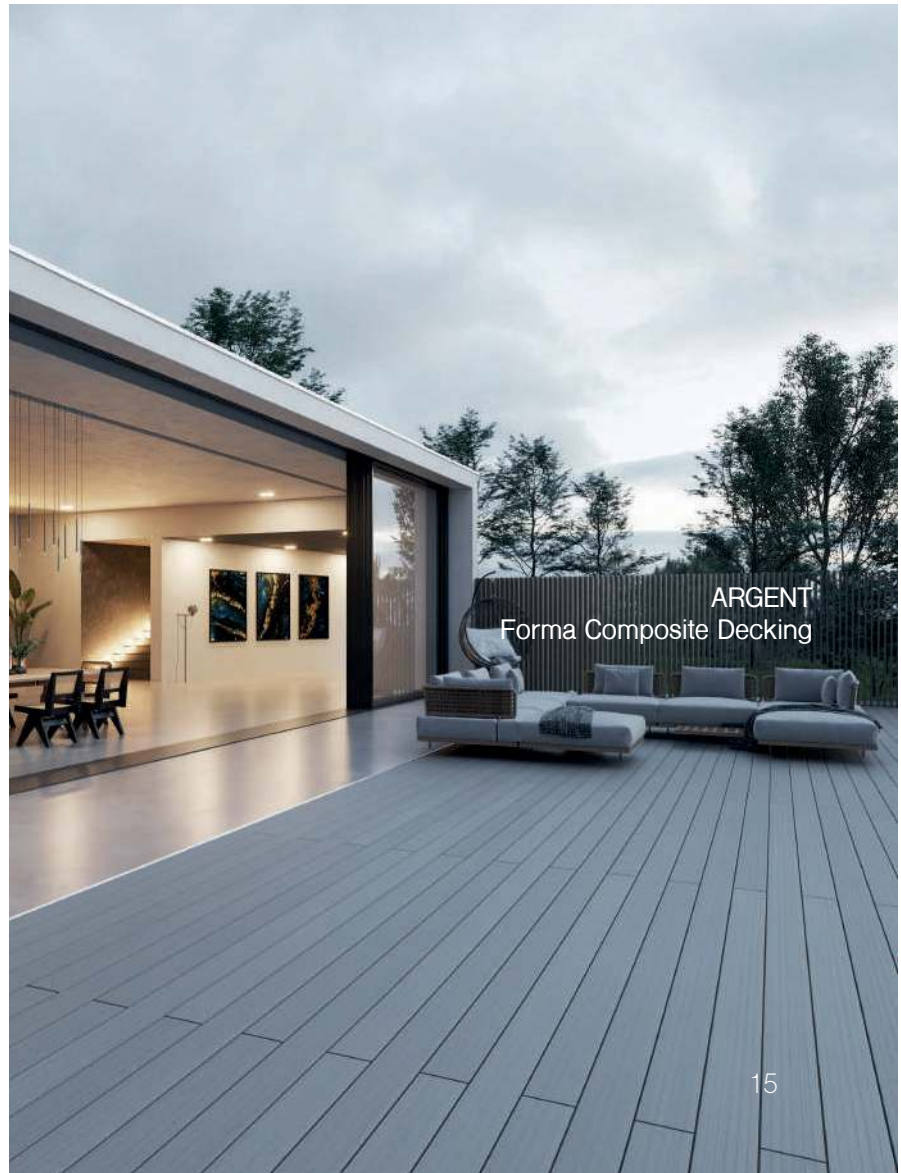

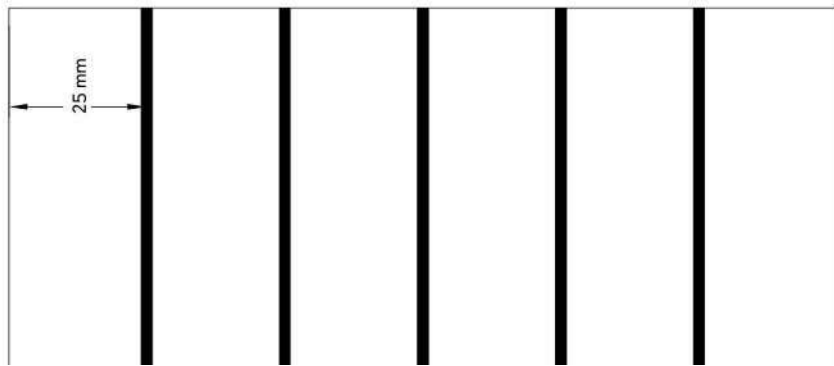
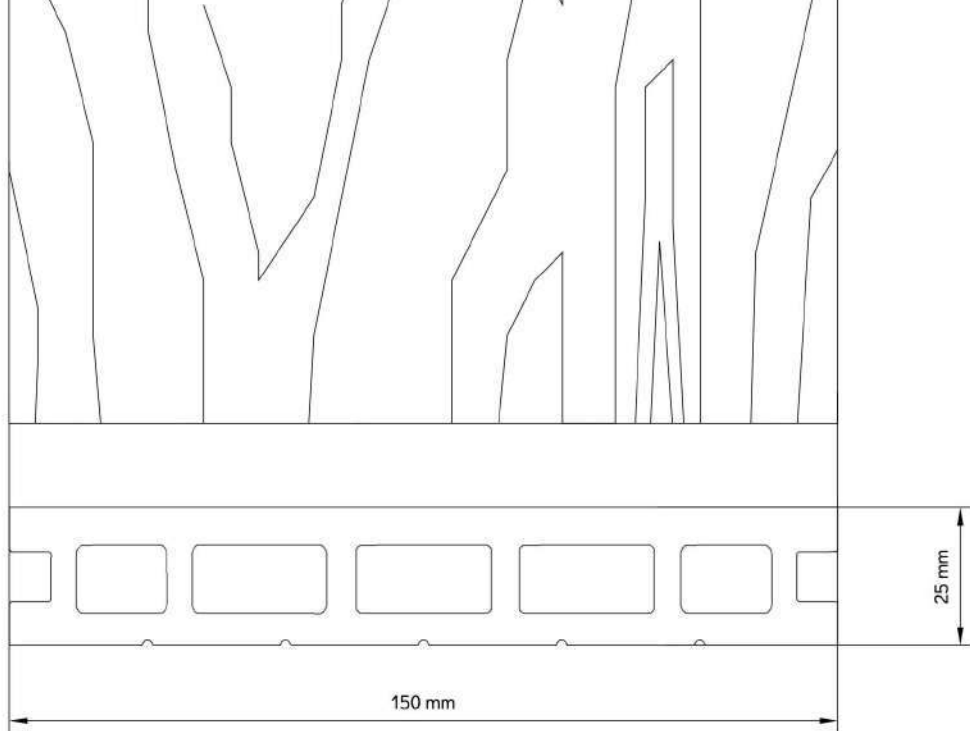

Forma's 360° co-extrusion durable capping is scratch and stain resistant, but also beautifully replicates the natural grain, dual tone and texture of timber.



With a 25 year warranty and UV bleaching resistant technology Forma decking requires minimal maintenance to keep its vibrant colour.

FORMA® COMPOSITE DECKING

Havana

150mm x 25mm x 3000mm

150mm x 25mm x 4800mm



Silver Birch

150mm x 25mm x 3000mm

150mm x 25mm x 4800mm

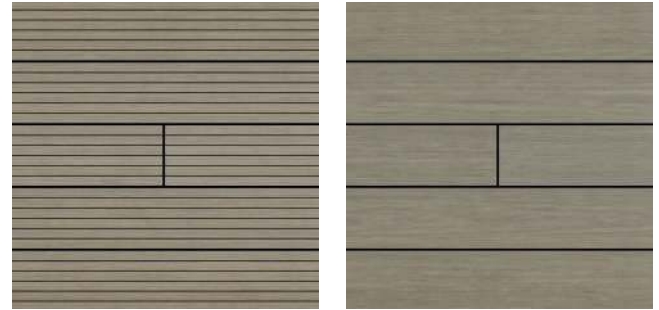

Spiced Oak

150mm x 25mm x 3000mm

150mm x 25mm x 4800mm

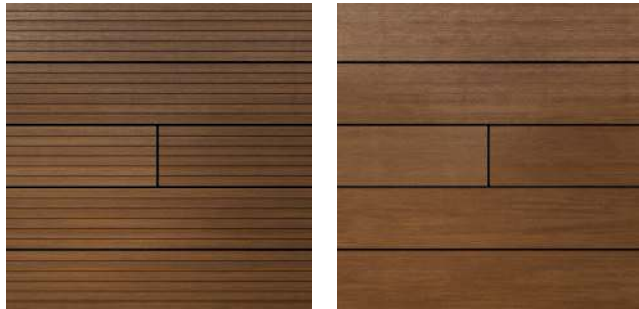

Dual surface boards; side 1 wide groove, side 2 woodgrain.

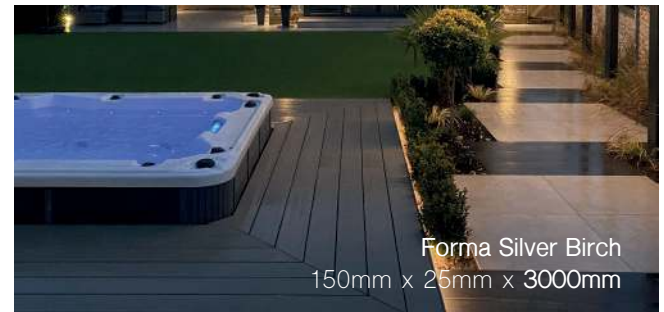

Flint

150mm x 25mm x 3000mm
150mm x 25mm x 4800mm



Argent

150mm x 25mm x 3000mm
150mm x 25mm x 4800mm



Midnight

150mm x 25mm x 3000mm
150mm x 25mm x 4800mm

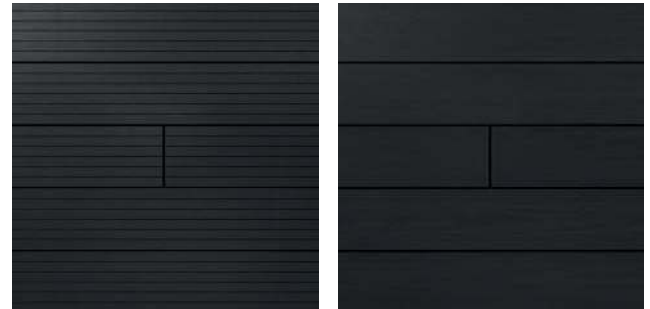

FORMA® COMPOSITE DECKING ACCESSORIES

Angle Fascia Trim
42mmx6mmx 3000mm



Flat Trim
10mmx150mmx3000mm



Finishing Board
80mmx15mmx3600mm



Hidden T-Clip Fixings
250 pcs
incl. screws and 1 drill bit



Locking Clip Fixings
50 pcs



Start/Finish Clips
50 pcs



Colour Coded Screws
50 pcs





BENEFITS OF FORMA® DECKING

Environmentally conscious design using 95% ethically sourced materials

Dura capping for UV and stain resistance.

Low maintenance – no need to paint, stain or seal

Does not rot, warp or splinter

Natural Looking without any of the drawbacks of timber

Easy Installation system with invisible fixings

Extensive 25 year warranty

BLACK ALUMINIUM
Aluminium Balustrade System with Glass

22

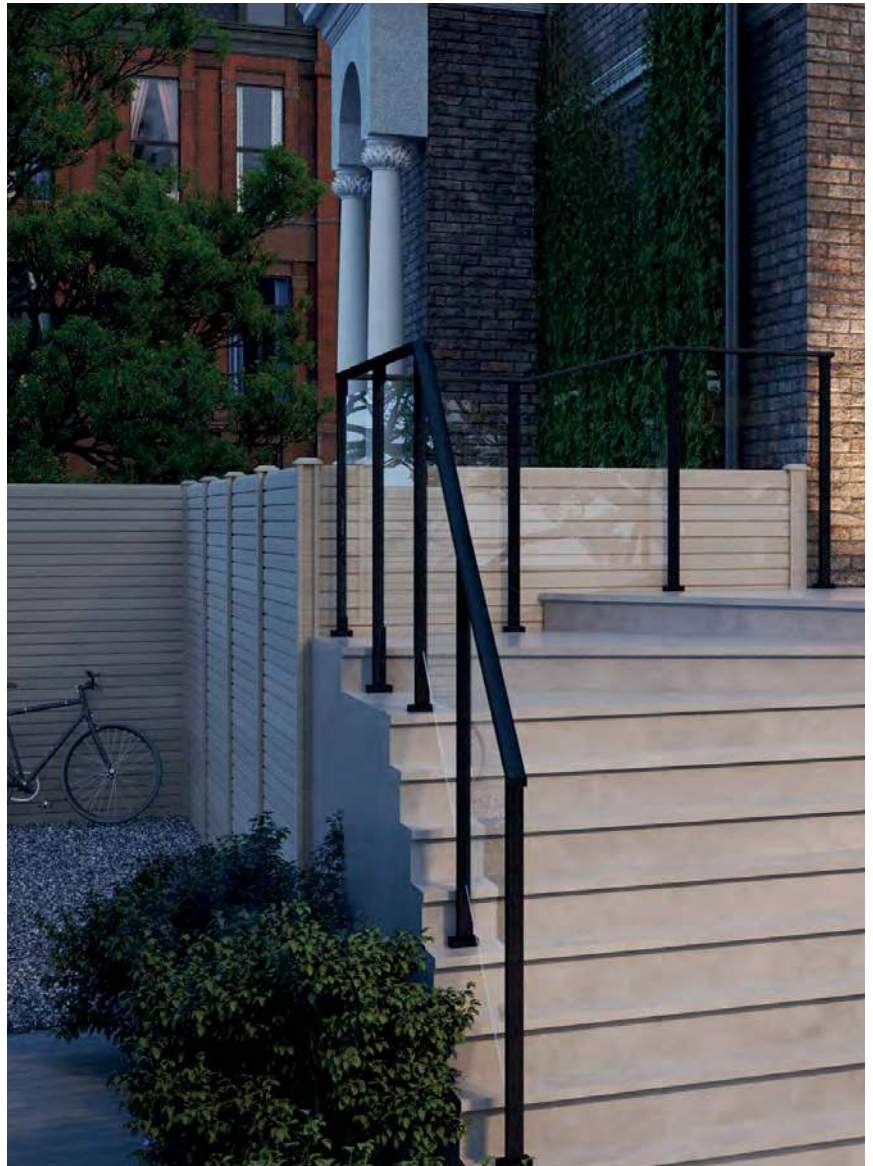

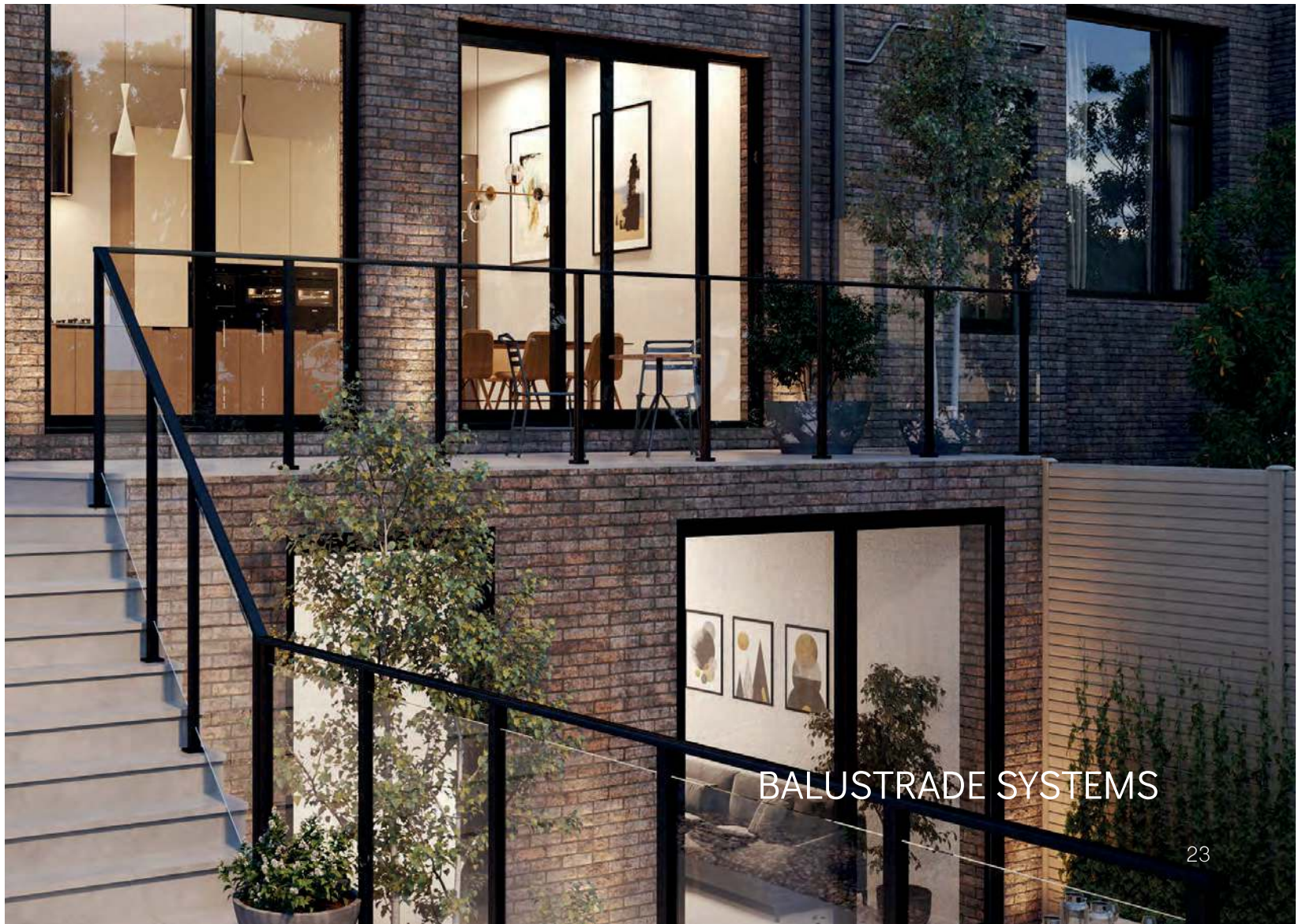

BALUSTRADE SYSTEMS

BALUSTRADE SYSTEMS

STAINLESS STEEL WITH
GLASS

Available in Black PC Finish Without Handrail



U CHANEL WITH GLASS
Stainless Steel

Without Handrail



ALUMINIUM WITH GLASS
Available in Black PC Finish

Without Handrail



FULL CLARITY COMPOSITE
BALUSTRADE
Available in all Clarity Colours



CLARITY COMPOSITE WITH
GLASS BALUSTRADE
Available in all Clarity Colours



ALUMINIUM RAILING +
Gate System Available



STAINLESS STEEL WITH
WIRE
Available in Black PC Finish



STAINLESS STEEL SPIGOT
Two Variations



HEX SPIGOT
Available in Black Powder
Coat Finish



Without Top Spigot



SILVER BIRCH
Forma Composite
Panel Cladding





FORMA[®] COMPOSITE PANEL CLADDING

Ecoscape Forma® composite cladding is a long lasting, low maintenance alternative to timber that can be used on various exterior projects; from home renovation to new build apartments, sunrooms or contemporary garden rooms.

Forma composite panel cladding is made up of recycled high density polyethylene plastic and reclaimed wood fibres. With a durable polymer outer shell encapsulating the board, it forms an impermeable layer that protects it from scratching and fading.



Our tongue and groove capped cladding profiles are available in six colours, utilise a hidden fixing system and have a choice of six innovative fixing trims.

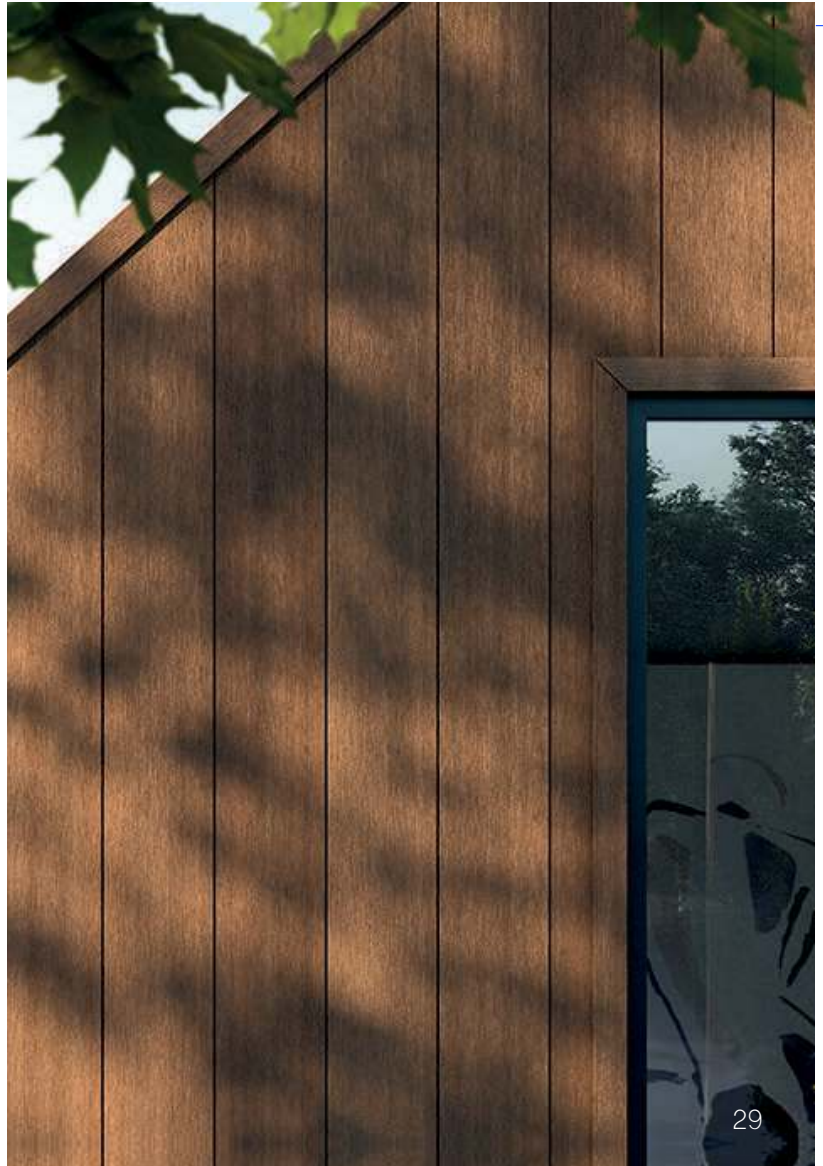

MIDNIGHT
Forma Composite
Panel Cladding



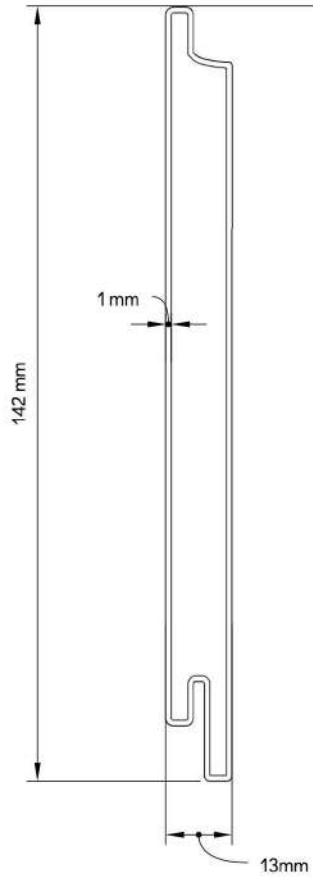

FORMA® COMPOSITE CLADDING

Havana

142mm x 13mm x 3600mm



Silver Birch

142mm x 13mm x 3600mm



Spiced Oak

142mm x 13mm x 3600mm



Flint

142mm x 13mm x 3600mm



Argent

142mm x 13mm x 3600mm

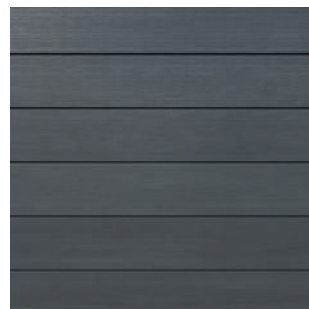

Midnight

142mm x 13mm x 3600mm

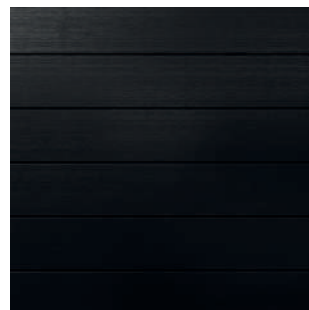

FORMA® COMPOSITE PANEL CLADDING TRIMS

F Shape Trim

47mmx46mmx3600mm



Angle Trim

40mmx40mmx3600mm



Internal Corner Trim

72mmx72mmx3600mm



External Corner Trim

72mmx72mmx3600mm



Joint Trim

79mmx24mmx3600mm



Finishing Board

80mmx15mmx3600mm





ARGENT
Forma Composite
Panel Cladding



FORMA® COMPOSITE SLATTED CLADDING

Forma Slatted Cladding is the perfect addition to any garden, extension or renovation and can instantly transform any project into a luxury space.

This stunning material from the capped Forma® range takes inspiration from natural timber cladding with no need to paint, stain or oil. Forma cladding products come with a 25 year warranty.



SILVER BIRCH
Forma Composite
Slatted Cladding



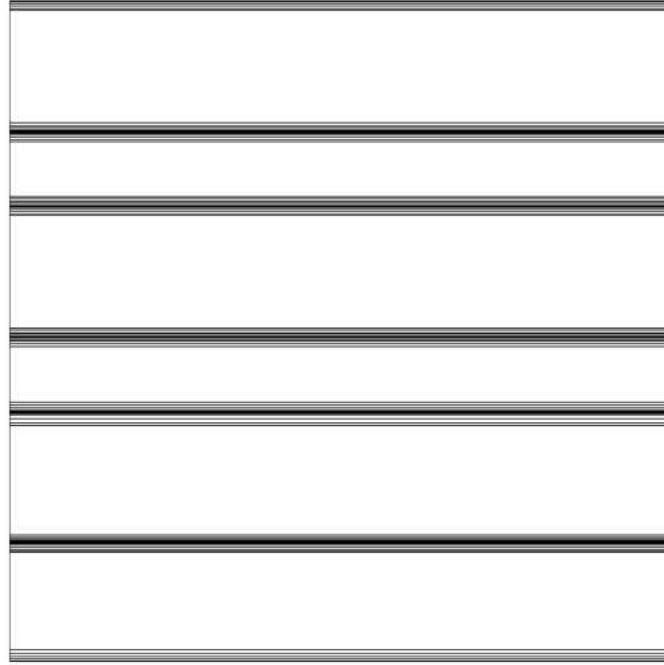
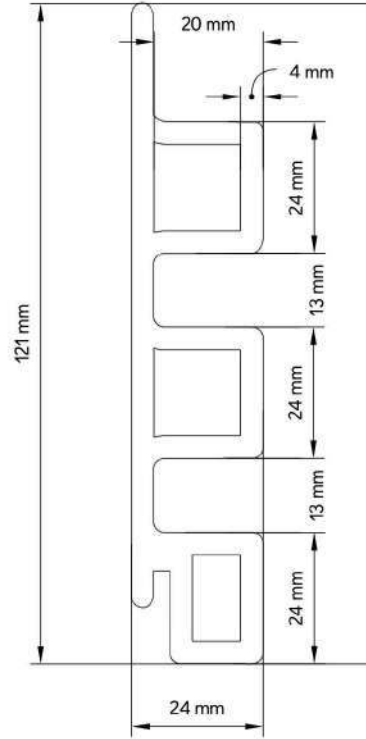

FORMA® COMPOSITE SLATTED CLADDING

Midnight

120mm x 25mm x 2500mm
120mm x 25mm x 3600mm



Silver Birch

120mm x 25mm x 2500mm
120mm x 25mm x 3600mm

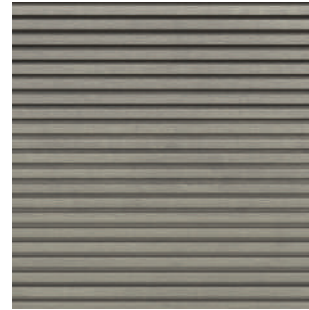

Spiced Oak

120mm x 25mm x 2500mm
120mm x 25mm x 3600mm



FORMA® COMPOSITE SLATTED CLADDING TRIMS & ACCESSORIES

Slatted Corner Trim
78mmx45mmx3600mm



Slatted End Trim
75mmx54mmx3600mm



Finishing Board
80mmx15mmx3600mm



Corner Trim
42mmx6 mmx3000mm



Aluminium Cladding Clips
250 pcs



Aluminium Starter Bar
3000mm



Plastic Pad
18mx8mm



**Cladding Clip
Wood Screw**



MATERIAL
SAMPLING



SILVER BIRCH
Forma Composite
Slatted Cladding



BENEFITS OF FORMA[®] CLADDING

Environmentally conscious design using 95% ethically sourced materials

Durable capping for UV and stain resistance

Low maintenance – no need to paint, stain or seal

Does not rot, warp or splinter

Natural Looking without any of the drawbacks of timber

Easy Installation system with invisible fixings

Extensive 25 year warranty



CLARITY® COMPOSITE FENCING & GATE SYSTEMS



Ecoscope's range of composite fencing and gates are an innovative modular wood plastic composite profile that stack to create any desired height. This creates a bespoke long lasting, low maintenance alternative to timber panels and gates.

Fence boards can either be retro-fit between existing fence posts or can be utilised in the fully composite post system; the perfect way to transform any garden into a luxury space.

This versatile system offers flexibility and style but also maintains the same environmentally friendly ethos as our other composite products and is made up of the same high quality recycled HDPE plastic and reclaimed wood fibres.

CHARCOAL
Clarity Composite
Fencing & Gate

MODULAR FENCING SYSTEM BREAKDOWN



SCAN FOR INSTALLATION GUIDES

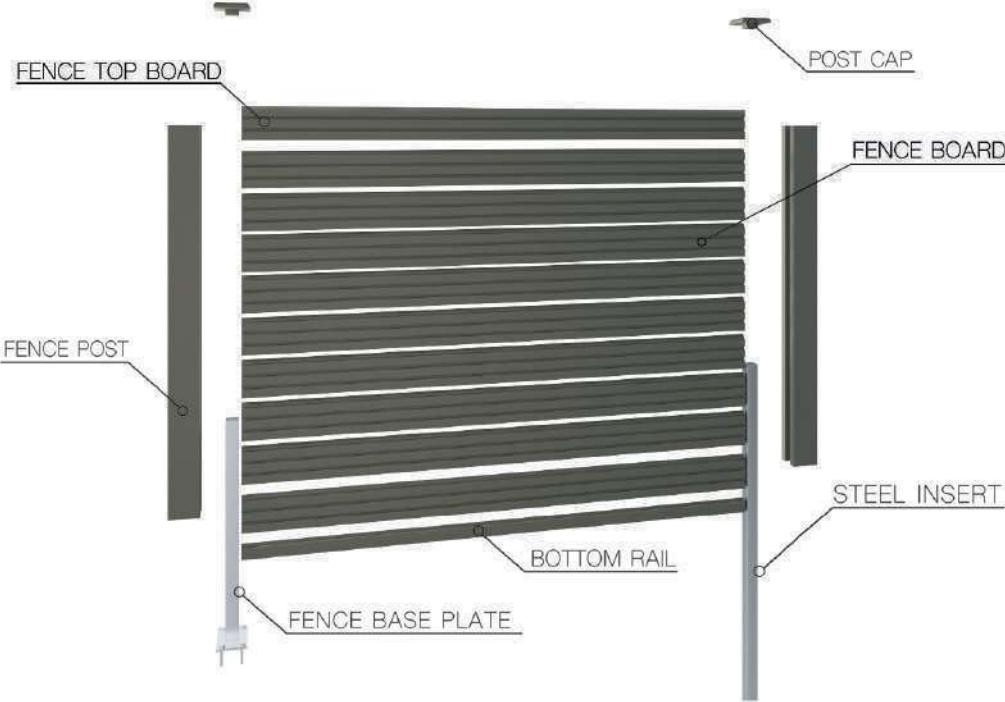

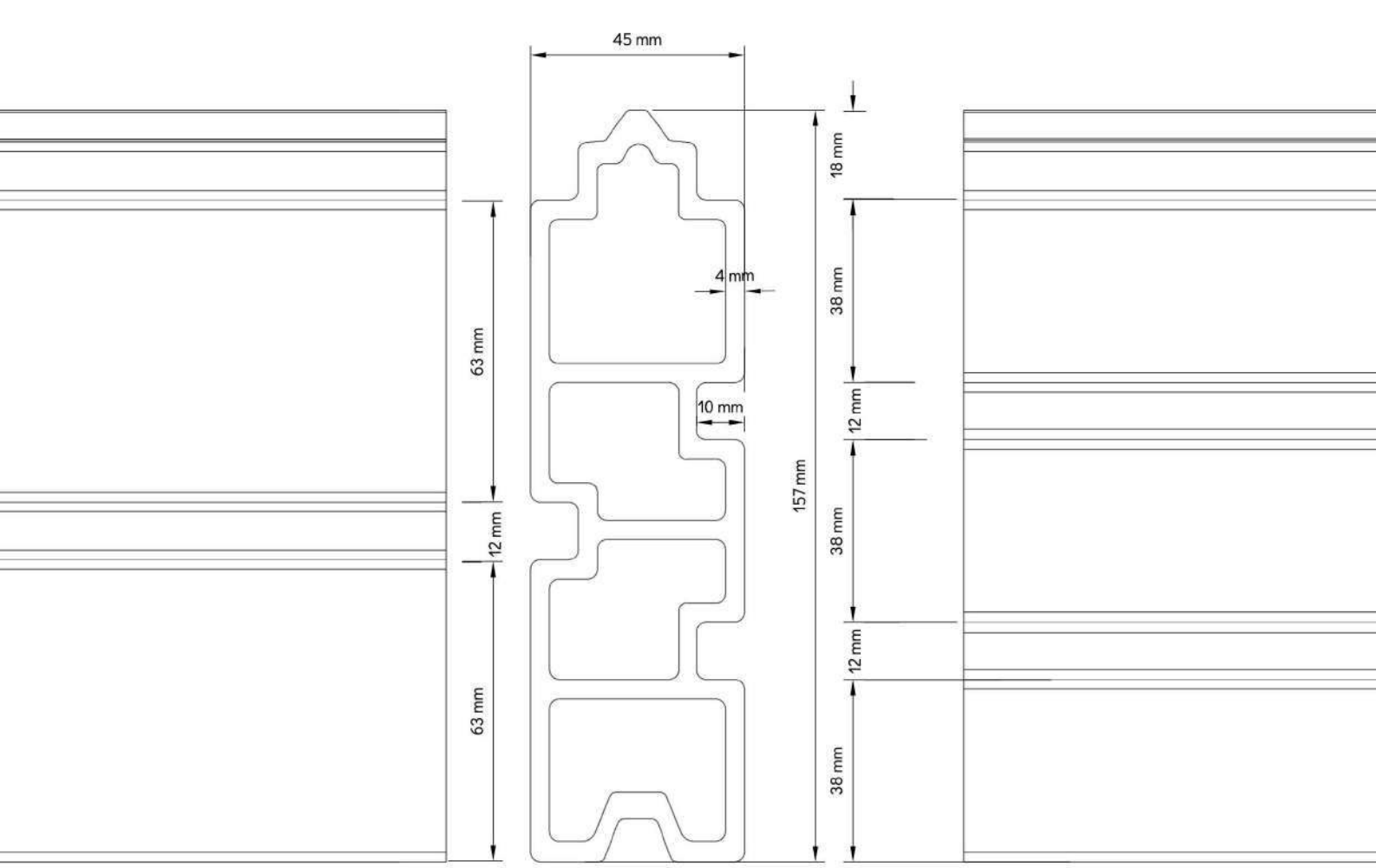

CLARITY® COMPOSITE FENCE BOARDS

Walnut

45mm x 157mm x 1830mm



Graphite

45mm x 157mm x 1830mm



Charcoal

45mm x 157mm x 1830mm

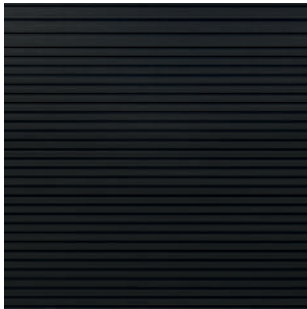

Dual surface boards; side 1 two 63mm battens, side 2 three 38mm battens

NOTE: Lighter Clarity boards will show greater colour settling due to smaller quantities of dye and greater UV exposure to the natural wood fibres. After 3 months of UV exposure colour remains consistent.

CLARITY® COMPOSITE GATE

Charcoal/Graphite/Walnut
52mm x 900mm x 1220mm



Charcoal/Graphite/Walnut
52mm x 900mm x 1520mm



Charcoal/Graphite/Walnut
52mm x 900mm x 1820mm



CLARITY® COMPOSITE FENCING COMPONENTS

Top Board
45mm x 139mm x 1830mm



End Post
125x125x1940/3000mm



Inter Post
125x125x1940/3000mm



Corner Post
125x125x1940/3000mm

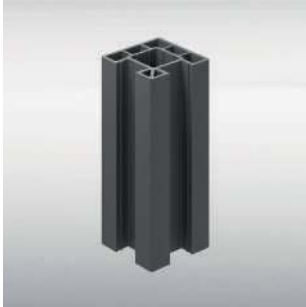

Post Cap
145mm x 145mm x 23mm



Steel Fence Base Plate
w/ Bolts - Black
125x190x900mm



Steel Post Insert
55x55x1940/3000mm



BENEFITS OF COMPOSITE FENCING & GATES

Modular system allowing for multiple design options.

3 Natural colours with matching gates in 4ft, 5ft & 6ft

Environmentally conscious design using 95% ethically sourced materials

Suitable for new project or retrofit between existing concrete posts

Quick and easy installation system

Strong and durable, storm resistant, 45mm thick boards

Extensive 20 year warranty.

PEDESTAL SYSTEMS



All of our decking & paving pedestals are made in Italy from 100% recycled polypropylene using advanced electric injection presses which release no emissions and no waste oil.

The four ranges of pedestal include King, Queen, Junior & Lord and are beautifully boxed in our 100% FSC® packaging. The range comes with a 15 year limited warranty (40+ year design life). We have 10 European registered patents, with our technology being unique to the market.

Across the four ranges you have the availability of self leveling base support, self leveling heads and fixed supports. Our tools section includes all ancillaries and finishing items to cater for most laying issues and needs.

For technical information visit ecoscapeuk.co.uk

Revolutionary Substructure Solutions



KING
K5 Paving Pedestal 53

KING DUAL ADJUSTMENT PEDESTALS - K1 -K15

This revolutionary patented pedestal has dual axis of movement for maximum accuracy of adjustment. The top is self-leveling, the bottom allows the installer to choose between fixed or self-leveling base, just by twisting the converter located under the tower. This additional bottom function can correct level differences up to 5% of the surface.

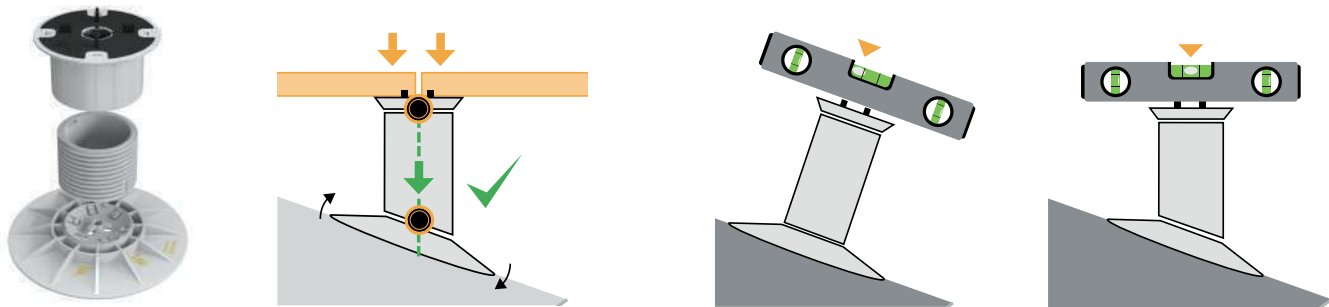

All of our pedestals are made up of 100% recycled high-quality polypropylene to create a sustainable and durable reinforced base and impact resistant screw. The King pedestal is the market's only recycled polypropylene support with a load capacity exceeding 1800kg.

QUEEN FIXED PEDESTALS - Q1 - Q15

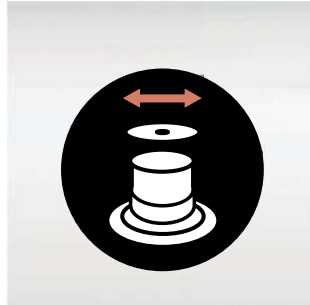

Queen is a reliable and durable raised floor support that is adjustable in height, with a fixed head. Ideal for multi-level renovations and projects that require operating at low heights. The Queen's minimum elevation height is just 21 mm, through to 1000mm+.

QUEEN PLUS ATTACHMENT

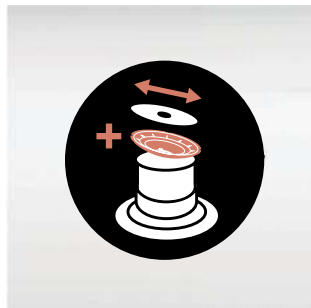

Queen pedestals are devised to be a fixed head, but with the application of a simple component between the screw and head, the queen plus attachment offers the option of self-leveling at the head to correct slopes of up to 5%. This transitions the Queen pedestal from fixed to a simple and practical self-leveling support.

DECKING PEDESTALS

King Dual Adjustment Pedestal
K1 30mm – K15 1089mm

King
Decking Head



Queen Pedestal
Q1 21mm – Q15 1224mm

Queen
Decking Head



KING	Sizes (mm)	Pieces per box		Sizes (mm)	Pieces per box
K1	30 – 41	20	K6 (K4+P1)	209 – 272	20
K2	41 – 63	20	K7 (K5+P1)	272 – 329	20
K3	63 – 95	20	K8 (K4+P1+P1)	329 – 380	20
K4	95 – 152	20	K9 (K5+P1)	380 – 436	20
K5	152 – 209	20	K10 (K5+P1+P1)	436 – 545	20
P1 <small>extension</small>	113	40	KDH	-	20

Can be stacked all the way to K15

QUEEN	Sizes (mm)	Pieces per box		Sizes (mm)	Pieces per box
Q1	21 – 30	25	QP1	28 – 37	25
Q2	29 – 44	25	QP2	36 – 51	25
Q3	43 – 72	25	QP3	50 – 79	25
Q4	70 – 126	25	QP4	77 – 133	25
Q5	124 – 234	25	QP5	131 – 341	25
Q PLUS	7	50	QDH	-	25

Can be stacked all the way to Q15/QP15

PAVING PEDESTALS

King Dual Adjustment Pedestal
K1 30mm – K15 1089mm



King
Paving Head



Queen Pedestal
Q1 21mm – Q15 1224mm



Queen
Paving Head



KING	Sizes (mm)	Pieces per box		Sizes (mm)	Pieces per box
K1	30 – 41	20	K6 (K4+P1)	209 – 272	20
K2	41 – 63	20	K7 (K5+P1)	272 – 329	20
K3	63 – 95	20	K8 (K4+P1+P1)	329 – 380	20
K4	95 – 152	20	K9 (K5+P1)	380 – 436	20
K5	152 – 209	20	K10 (K5+P1+P1)	436 – 545	20
P1 extension	113	40			

Can be stacked all the way to K15

QUEEN	Sizes (mm)	Pieces per box		Sizes (mm)	Pieces per box
Q1	21 – 30	25	QP1	28 – 37	25
Q2	29 – 44	25	QP2	36 – 51	25
Q3	43 – 72	25	QP3	50 – 79	25
Q4	70 – 126	25	QP4	77 – 133	25
Q5	124 – 234	25	QP5	131 – 341	25
Q PLUS	7	50			

Can be stacked all the way to Q15/QP15

JUNIOR MINOR ADJUSTMENT PEDESTALS

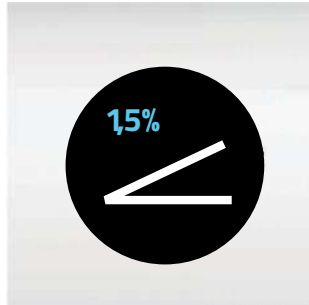

Junior is an extremely low 12 mm to 30 mm support with a self-leveling base and functions without additional extensions. The movement of the screw runs between the head and the self-leveling base which allows easy leveling of the floor and capable of adjusting slopes of up to 1.5%.

LORD MODULAR CRADLES

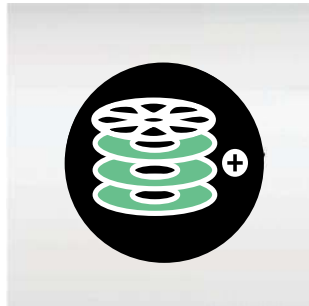

Lord cradles are fixed at 8 mm and can be heightened by increments of 4 mm when adding the Lord extension beneath the support. Lord is an effective solution in minor adjustment renovations and in all projects where very low heights are required.

*Lord & Junior systems are only suitable for paving systems

Junior

J1 12mm - J3 30mm



Paving Head



Lord

Cradle 8mm + 4mm pads



Paving Head



JUNIOR	Sizes (mm)	Pieces per box
J1	12 - 18	20
J2	18 - 24	20
J3	24 - 30	20



LORD	Sizes (mm)	Pieces per box
L	8	25
EXTENSION	4	25





FORTE TIMBER FREE SUPPORT SYSTEMS

50mm x 50mm
Forte Plastic Joist



Using only the highest grade 100% recycled plastics we produce extremely strong and durable plastic joists/battens as an alternative to using a timber substructure. With profiles suitable for both decking and cladding these solutions are especially beneficial in the damp British climate where timber can be compromised in a matter of a few years.

We also offer a recycled aluminium support system. Extremely light weight and durable – aluminium does not warp, shrink, swell like timber and remains perfectly straight throughout its 80+ year lifespan. The recycling process only takes up 5% of the energy used during its manufacturing and the quality of recycle aluminium is the same as that of new.

FORTE TIMBER FREE JOISTS/BATTENS

Forte Plastic Decking Joist
50mmx50mmx2400mm



Forte Plastic Decking Joist
125mmx50mmx3000mm



Forte Plastic Decking Post
100mmx 100mmx3000mm



Forte Plastic Cladding Battens
25mmx50mmx3000mm
20mmx 100mmx2800mm



Aluminium Joist
40mmx40mmx3000mm



Tech Pedestal Rail Joist
70mmx25mmx2000mm

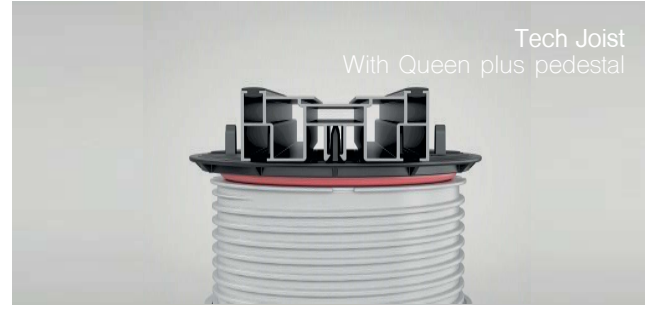



ARGENT
Forma Composite
Decking + Q3 Pedestals

An aerial photograph of a river flowing through a narrow, rocky canyon. The water is a vibrant turquoise color, contrasting with the dark, rugged rock walls. The river flows from the top center towards the bottom, with white foam visible in some areas. The overall scene is dramatic and natural.

ENVIRONMENTAL SUSTAINABILITY

All of our composite materials are made using a mixture of reclaimed timber fibres, recycled HDPE and environmentally sustainable bonding agents and dyes to create high quality products that replicate the characteristics of timber without any of the drawbacks; like rotting, warping, drastic colour fading, ongoing maintenance etc.

The use of recycled HDPE plastics helps aid in the battle to reduce landfill and ocean plastics but also reducing our carbon footprint.

For more information about our sustainability visit
ecoscape.co.uk